

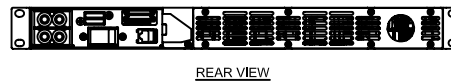

81204-P1B21C3		IDS1200-3 WITH BREAKER DISTRIBUTION	
--			
DIMENSIONS ARE IN INCHES		INITIALS	DATE
TOLERANCES:		DRAWN CH	9/26/2006
DECIMALS: .XX ±.02	ANGLES: ±1°	CHECKED --	--/--
MATERIAL: --		THE INFORMATION CONTAINED IN THIS DRAWING IS THE SOLE PROPERTY OF C&C POWER, INC. ANY REPRODUCTION WITHOUT THE WRITTEN CONSENT OF C&C POWER, INC IS PROHIBITED.	
FINISH: --		 C&C POWER, INC. 949 N. Larch Ave. Elmhurst, IL 60126	
CAD GENERATED DRAWING DO NOT MANUALLY UPDATE			
SCALE: NTS	SIZE: A	REV: A	SHEET 1 OF 1
		© 2006 C&C POWER, INC. ALL RIGHTS RESERVED	

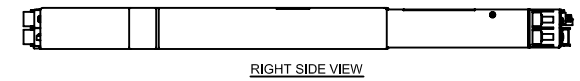
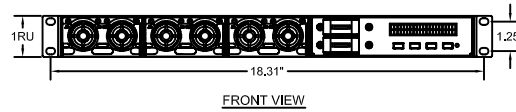
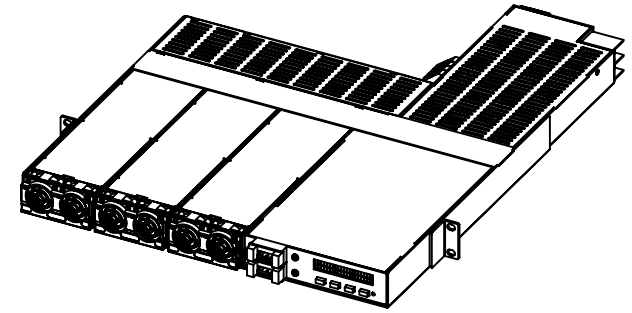
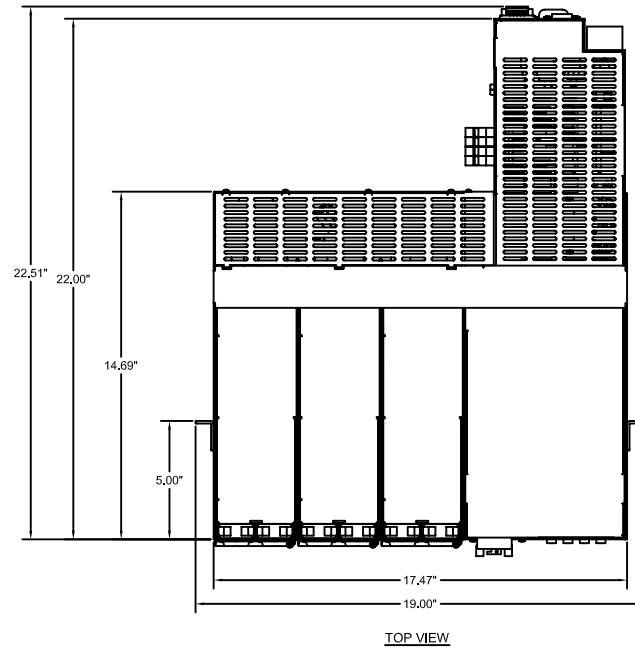
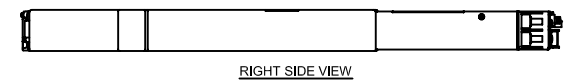
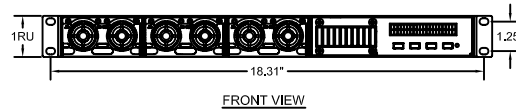
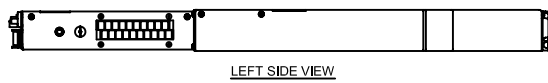
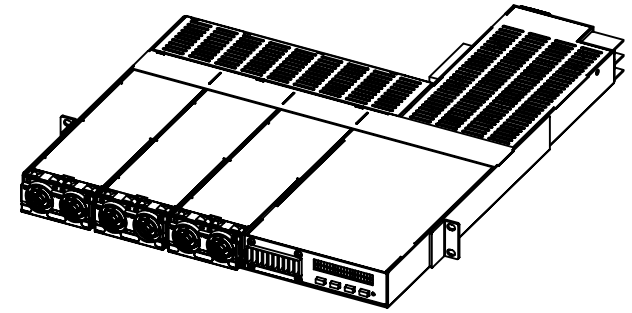
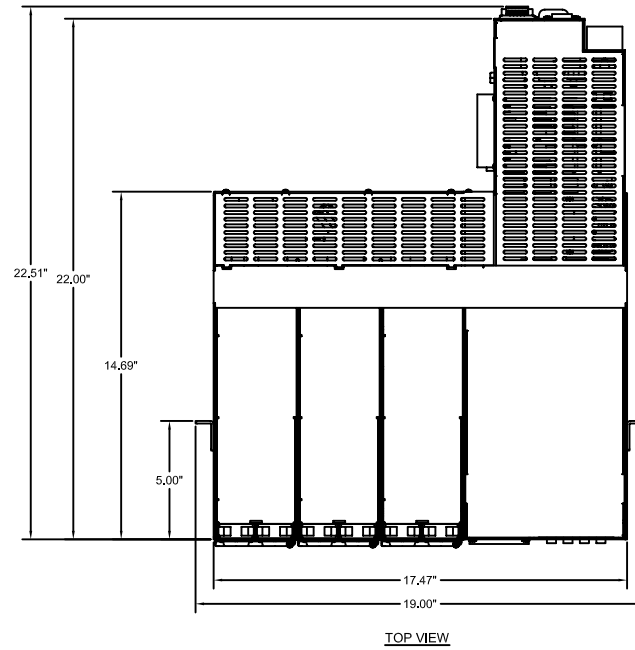

81204-P1F21C3		IDS1200-3 WITH FUSED PULLOUT DISTRIBUTION	
--			
DIMENSIONS ARE IN INCHES	INITIALS	DATE	THE INFORMATION CONTAINED IN THIS DRAWING IS THE SOLE PROPERTY OF C&C POWER, INC. ANY REPRODUCTION WITHOUT THE WRITTEN CONSENT OF C&C POWER, INC IS PROHIBITED.
TOLERANCES:	DRAWN CH	9/26/2006	
DECIMALS: .XXX ±.02	CHECKED --	--/--	
MATERIAL: --			
FINISH: --			
CAD GENERATED DRAWING DO NOT MANUALLY UPDATE			
SCALE: NTS	SIZE: A	REV: A	SHEET 1 OF 1

C&C POWER, INC.
 949 N. Larch Ave.
 Elmhurst, IL 60126
 © 2006 C&C POWER, INC.
 ALL RIGHTS RESERVED



81204-P1G21C3		IDS1200-3 WITH GMT FUSE DISTRIBUTION	
--			
DIMENSIONS ARE IN INCHES		INITIALS	DATE
TOLERANCES:		DRAWN CH	9/26/2006
DECIMALS: .XX ±.02	ANGLES: ±1°	CHECKED --	--/--
MATERIAL: --		FINISH: --	
CAD GENERATED DRAWING DO NOT MANUALLY UPDATE		 C&C POWER, INC. 949 N. Larch Ave. Elmhurst, IL 60126 © 2006 C&C POWER, INC. ALL RIGHTS RESERVED	
SCALE: NTS	SIZE: A	REV: A	SHEET 1 OF 1